

A black and white photograph of a modern interior space, viewed from a lower level. The space is enclosed by a glass wall and ceiling. Inside, there is a desk with a chair, a large armchair, and a coffee table. The ceiling has recessed lighting. The overall aesthetic is clean and minimalist.

ONLEVEL

**KAZIWALL**  
ROOM HEIGHT FALL PROTECTION

# KAZIWALL

Room height fall protection for indoor and outdoor use

## KAZIWALL

He is the Knight of Unobtrusiveness. He does not cross limits because he is so steadfast. But he can separate entire worlds, therefore you may want to view him from more than one angle. Next to him, the furniture are taking their positions, the plants bending subserviently in front of him, the wind fluffs up and the balcony is committed to coziness.

He is the Master of the Great Bang but also protects from noise.

Rather a bang than a whimper with **KAZIWALL!**

**KAZIWALL** is the one and only room divider. It is suitable for indoor and outdoor use and available with fall protection. It serves as a room divider across several floors or as a windscreen on balconies or terraces.

## Essential Features

- | Easy and safe installation for single glass fixation method
- | Max ceiling height 3.0 m
- | In case of fall protection, max. load 1.0 kN/m
- | Top mount for both ceiling and floor
- | For glass thickness 16.76 mm, 17.52 mm and 21.52 mm
- | Standard glass width  $\geq 1000$  mm. Customized glass width also possible.
- | Prefabricated System

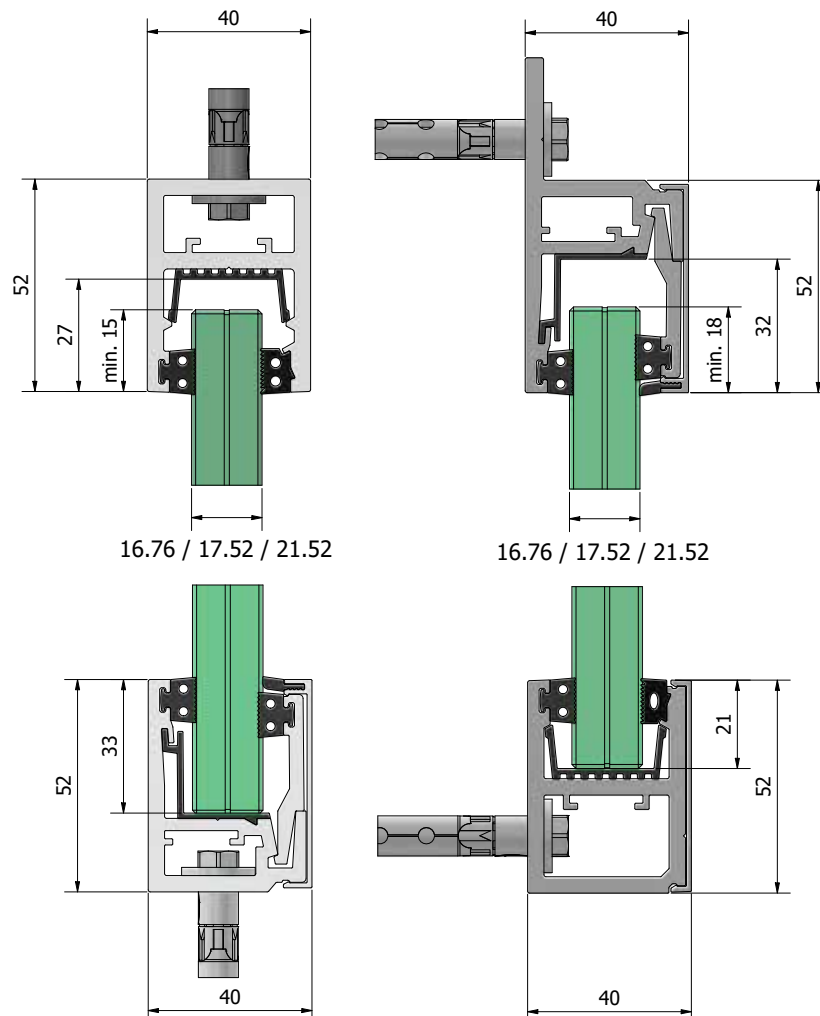



Plug and Play System

Fall protection system

Easy to mount. Prefabricated System.

**KAZIWALL** | OUTDOOR USE





# KAZIWALL | TOP

## KAZIWALL Top



| Prefabricated System  
| 1-piece top mount profile  
| Sales unit: 1 piece

Length/Glass thickness	2500 mm / 16.76 mm / 17.52 mm	5000 mm / 16.76 mm / 17.52 mm	2500 mm /21.52 mm	5000 mm/21.52 mm
Colour	Art. no.	Art. no.	Art. no.	Art. no.
mill finish	20.4002.017.10	20.4005.017.10	20.4002.022.10	20.4005.022.10
natural anodized	20.4002.017.11	20.4005.017.11	20.4002.022.11	20.4005.022.11
RAL shiny	20.4002.017.13	20.4005.017.13	20.4002.022.13	20.4005.022.13
RAL struct.	20.4002.017.16	20.4005.017.16	20.4002.022.16	20.4005.022.16
RAL matt	20.4002.017.18	20.4005.017.18	20.4002.022.18	20.4005.022.18
ARMOR RAL	20.4002.017.19	20.4005.017.19	20.4002.022.19	20.4005.022.19

## KAZIWALL Top 2 Pieces



| Prefabricated System  
| 2-piece top mount profile  
| Sales unit: 1 piece

Note: Intermediate profiles in L=900mm to secure each glass panel separately

Length/Glass thickness	2500 mm / 16.76 mm / 17.52 mm	5000 mm / 16.76 mm / 17.52 mm	2500 mm /21.52 mm	5000 mm/21.52 mm
Colour	Art. no.	Art. no.	Art. no.	Art. no.
mill finish	20.4502.017.10	20.4505.017.10	20.4502.022.10	20.4505.022.10
natural anodized	20.4502.017.11	20.4505.017.11	20.4502.022.11	20.4505.022.11
RAL shiny	20.4502.017.13	20.4505.017.13	20.4502.022.13	20.4505.022.13
RAL struct.	20.4502.017.16	20.4505.017.16	20.4502.022.16	20.4505.022.16
RAL matt	20.4502.017.18	20.4505.017.18	20.4502.022.18	20.4505.022.18
ARMOR RAL	20.4502.017.19	20.4505.017.19	20.4502.022.19	20.4505.022.19

## KAZIWALL Side wall profile



| Prefabricated System  
| Length: 3000 mm  
| Sales unit: 1 piece

Glass thickness	16.76 mm / 17.52 mm	21.52 mm
Colour	Art. no.	Art. no.
mill finish	20.5003.017.10	20.5003.022.10
natural anodized	20.5003.017.11	20.5003.022.11
RAL shiny	20.5003.017.13	20.5003.022.13
RAL struct.	20.5003.017.16	20.5003.022.16
RAL matt	20.5003.017.18	20.5003.022.18
ARMOR RAL	20.5003.017.19	20.5003.022.19

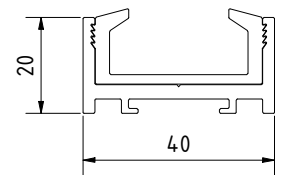

## KAZIWALL Endcap



| Sales unit: 8 pieces

Colour	Art. no.
mill finish	20.9010.000.10
natural anodized	20.9010.000.11
RAL shiny	20.9010.000.13
RAL struct.	20.9010.000.16
RAL matt	20.9010.000.18
ARMOR RAL	20.9010.000.19

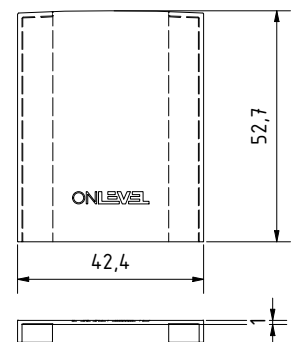



# KAZIWALL | SIDE

## KAZIWALL SIDE



| Prefabricated System  
| Sales unit: 1 piece

Length/Glass thickness	2500 mm / 16.76 mm / 17.52 mm	5000 mm / 16.76 mm / 17.52 mm	2500 mm /21.52 mm	5000 mm/21.52 mm
Colour	Art. no.	Art. no.	Art. no.	Art. no.
mill finish	20.4102.017.10	20.4105.017.10	20.4102.022.10	20.4105.022.10
natural anodized	20.4102.017.11	20.4105.017.11	20.4102.022.11	20.4105.022.11
RAL shiny	20.4102.017.13	20.4105.017.13	20.4102.022.13	20.4105.022.13
RAL struct.	20.4102.017.16	20.4105.017.16	20.4102.022.16	20.4105.022.16
RAL matt	20.4102.017.18	20.4105.017.18	20.4102.022.18	20.4105.022.18
ARMOR RAL	20.4102.017.19	20.4105.017.19	20.4102.022.19	20.4105.022.19

## KAZIWALL SIDE 2 Pieces



| Prefabricated System  
| Sales unit: 1 piece

Note: Intermediate profiles in L=900mm  
to secure each glass panel separately

Length/Glass thickness	2500 mm / 16.76 mm / 17.52 mm	5000 mm / 16.76 mm / 17.52 mm	2500 mm /21.52 mm	5000 mm/21.52 mm
Colour	Art. no.	Art. no.	Art. no.	Art. no.
mill finish	20.4602.017.10	20.4605.017.10	20.4602.022.10	20.4605.022.10
natural anodized	20.4602.017.11	20.4605.017.11	20.4602.022.11	20.4605.022.11
RAL shiny	20.4602.017.13	20.4605.017.13	20.4602.022.13	20.4605.022.13
RAL struct.	20.4602.017.16	20.4605.017.16	20.4602.022.16	20.4605.022.16
RAL matt	20.4602.017.18	20.4605.017.18	20.4602.022.18	20.4605.022.18
ARMOR RAL	20.4602.017.19	20.4605.017.19	20.4602.022.19	20.4605.022.19





## Fixation anchor Fischer FH II 10/10 S AISI 316

- | For outside use
- | Sales unit: 50 pieces

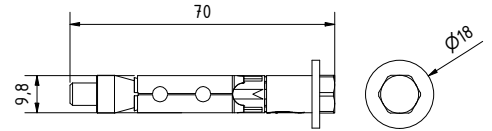

Art. no.

91.3521.010.30

---

## Fixation anchor Fischer SXRL 10x60 FUS steel zinc plated

- | For inside use
- | Sales unit: 50 pieces

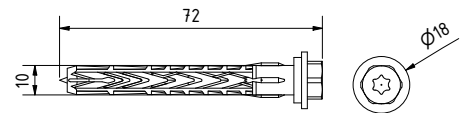

Art. no.

91.3581.060.81

---

## DUOPOWER 8 mm x 65 mm

- | For wall mount of side wall profile
- | Suitable screws: Countersunk screw 5 mm x 70 mm, A2
- | Sales unit: 50 pieces



Duopower

Art. no.

Duopower 8 x 65 S A2

91.3560.865.20

---

## Tape 69



| Particularly suitable for applications where a transparent, flexible bond is required.  
 | For inside use  
 | Length: 12 m, Thickness: 3 mm  
 | Sales unit: 1 piece



Model 7025		
Width	Glass thickness	Art. no.
5 mm	8 - 8.76 mm	90.7025.008.03
7 mm	10 - 10.76 mm	90.7025.010.03
9 mm	12 - 12.76 mm	90.7025.012.03
13 mm	16.76 - 17.52 mm	90.7025.016.03
17 mm	20.76 - 21.52 mm	90.7025.020.03

## Tape 69 mounting tool



| Sales unit: 1 piece

Model 0100	
For glass thicknesses	Art. no.
8/8.76 and 10/10.76 mm	90.0100.170.08
12/12.76 and 16.76/17.52 mm	90.0100.170.12
16.76/17.52 and 20.76/21.52 mm	90.0100.170.16

# KAZIWALL | TOP

## KAZIWALL Tool



| Sales unit: 1 piece

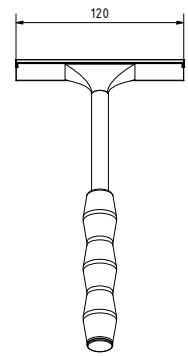

**Art. no.**

90.0100.190.00

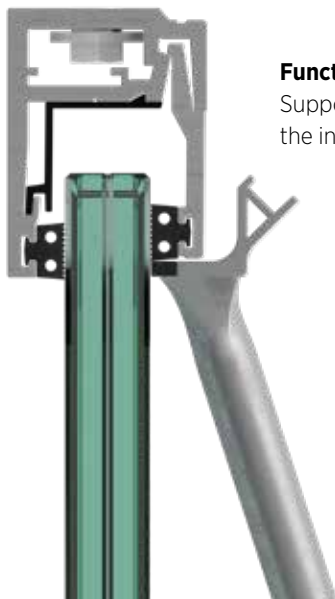

**Function 1:**  
Support tool to hammer-in  
the intermediate profile

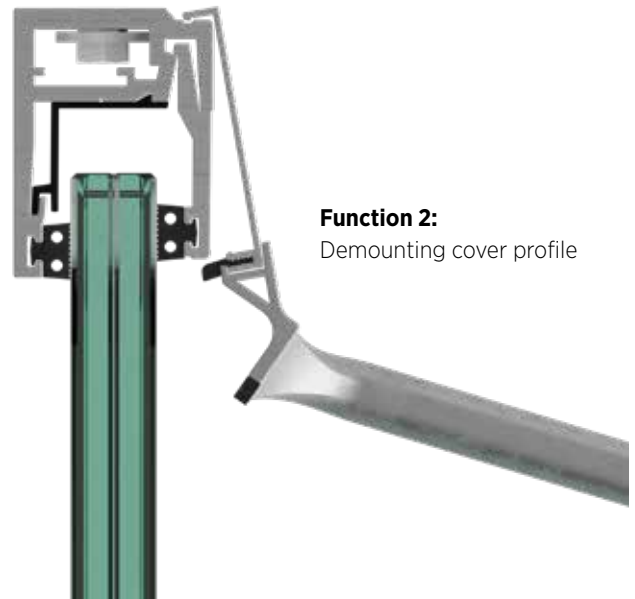

**Function 2:**  
Demounting cover profile

## Usage data as per load capacity

### Indoor (inside wall)

	Line load	Glass thickness	Height (max)
Private	0.5 kN/m	16.76 mm / 17.52 mm	3000 mm
Public	1.0 kN/m	21.52 mm	3000 mm

### Outdoor (as part of exterior wall)

	Line load	Glass thickness	Height (max)	qp(z) max.
Private/Public	1.0 kN/m	21.52mm	2600 mm	1.41 kN/m <sup>2</sup>
Private/Public	1.0 kN/m	21.52 mm	3000 mm	0.93 kN/m <sup>2</sup>

\*All glass calculations are done for laminated toughened glass (ESG)





**ONLEVEL**

**ONLEVEL GmbH** | Budberger Straße 5 | 46446 Emmerich am Rhein | Germany  
+49 (0)2822 97514-0 | [info@onlevel.com](mailto:info@onlevel.com) | [www.onlevel.com](http://www.onlevel.com)