

A black and white photograph of a modern interior space, viewed from a lower level. The space is enclosed by a glass wall and ceiling, creating a transparent barrier. Inside, there is a desk with a chair, a large armchair, and a coffee table. The ceiling is made of horizontal slats, and there are recessed lights. The floor is covered with a patterned rug. The overall aesthetic is clean and minimalist. A bright green vertical bar is on the left side of the image.

ONLEVEL

KAZIWALL
ROOM HEIGHT FALL PROTECTION

KAZIWALL

Room height fall protection for indoor and outdoor use

KAZIWALL

He is the Knight of Unobtrusiveness. He does not cross limits because he is so steadfast. But he can separate entire worlds, therefore you may want to view him from more than one angle. Next to him, the furniture are taking their positions, the plants bending subserviently in front of him, the wind fluffs up and the balcony is committed to coziness.

He is the Master of the Great Bang but also protects from noise.

Rather a bang than a whimper with **KAZIWALL!**

KAZIWALL is the one and only room divider. It is suitable for indoor and outdoor use and available with fall protection. It serves as a room divider across several floors or as a windscreen on balconies or terraces.

Essential Features

- | Easy and safe installation for single glass fixation method
- | Max ceiling height 3.0 m
- | In case of fall protection, max. load 1.0 kN/m
- | Top mount for both ceiling and floor
- | For glass thickness 16.76 mm, 17.52 mm and 21.52 mm
- | Standard glass width ≥ 1000 mm. Customized glass width also possible.
- | Prefabricated System

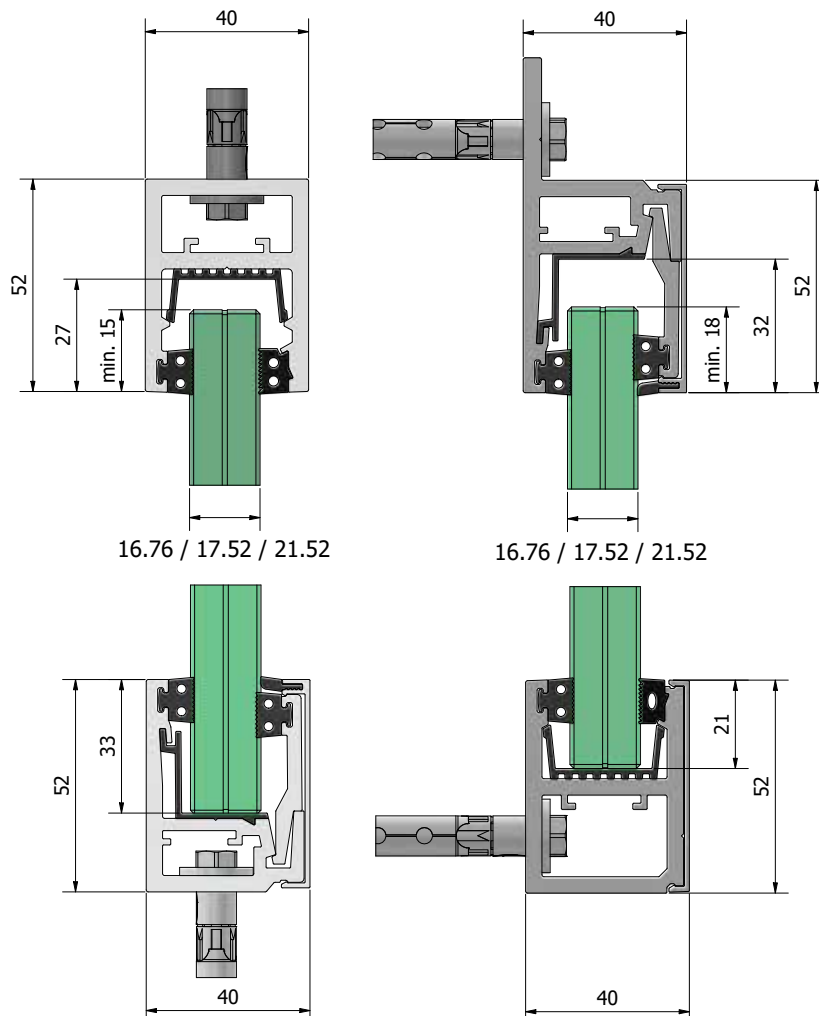



Plug and Play System

Fall protection system

Easy to mount. Prefabricated System.

KAZIWALL | OUTDOOR USE





KAZIWALL | TOP

KAZIWALL Top



| Prefabricated System
| 1-piece top mount profile
| Sales unit: 1 piece

Length/Glass thickness	2500 mm / 16.76 mm / 17.52 mm	5000 mm / 16.76 mm / 17.52 mm	2500 mm /21.52 mm	5000 mm/21.52 mm
Colour	Art. no.	Art. no.	Art. no.	Art. no.
mill finish	20.4002.017.10	20.4005.017.10	20.4002.022.10	20.4005.022.10
natural anodized	20.4002.017.11	20.4005.017.11	20.4002.022.11	20.4005.022.11
RAL shiny	20.4002.017.13	20.4005.017.13	20.4002.022.13	20.4005.022.13
RAL struct.	20.4002.017.16	20.4005.017.16	20.4002.022.16	20.4005.022.16
RAL matt	20.4002.017.18	20.4005.017.18	20.4002.022.18	20.4005.022.18
ARMOR RAL	20.4002.017.19	20.4005.017.19	20.4002.022.19	20.4005.022.19

KAZIWALL Top 2 Pieces



| Prefabricated System
| 2-piece top mount profile
| Sales unit: 1 piece

Note: Intermediate profiles in L=900mm to secure each glass panel separately

Length/Glass thickness	2500 mm / 16.76 mm / 17.52 mm	5000 mm / 16.76 mm / 17.52 mm	2500 mm /21.52 mm	5000 mm/21.52 mm
Colour	Art. no.	Art. no.	Art. no.	Art. no.
mill finish	20.4502.017.10	20.4505.017.10	20.4502.022.10	20.4505.022.10
natural anodized	20.4502.017.11	20.4505.017.11	20.4502.022.11	20.4505.022.11
RAL shiny	20.4502.017.13	20.4505.017.13	20.4502.022.13	20.4505.022.13
RAL struct.	20.4502.017.16	20.4505.017.16	20.4502.022.16	20.4505.022.16
RAL matt	20.4502.017.18	20.4505.017.18	20.4502.022.18	20.4505.022.18
ARMOR RAL	20.4502.017.19	20.4505.017.19	20.4502.022.19	20.4505.022.19

KAZIWALL Side wall profile



| Prefabricated System
| Length: 3000 mm
| Sales unit: 1 piece

Glass thickness	16.76 mm / 17.52 mm	21.52 mm
Colour	Art. no.	Art. no.
mill finish	20.5003.017.10	20.5003.022.10
natural anodized	20.5003.017.11	20.5003.022.11
RAL shiny	20.5003.017.13	20.5003.022.13
RAL struct.	20.5003.017.16	20.5003.022.16
RAL matt	20.5003.017.18	20.5003.022.18
ARMOR RAL	20.5003.017.19	20.5003.022.19

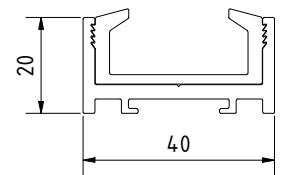

KAZIWALL Endcap



| Sales unit: 8 pieces

Colour	Art. no.
mill finish	20.9010.000.10
natural anodized	20.9010.000.11
RAL shiny	20.9010.000.13
RAL struct.	20.9010.000.16
RAL matt	20.9010.000.18
ARMOR RAL	20.9010.000.19

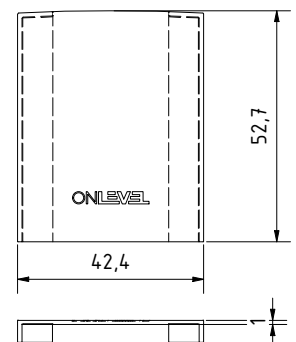



KAZIWALL | SIDE

KAZIWALL SIDE



| Prefabricated System
| Sales unit: 1 piece

Length/Glass thickness	2500 mm / 16.76 mm / 17.52 mm	5000 mm / 16.76 mm / 17.52 mm	2500 mm /21.52 mm	5000 mm/21.52 mm
Colour	Art. no.	Art. no.	Art. no.	Art. no.
mill finish	20.4102.017.10	20.4105.017.10	20.4102.022.10	20.4105.022.10
natural anodized	20.4102.017.11	20.4105.017.11	20.4102.022.11	20.4105.022.11
RAL shiny	20.4102.017.13	20.4105.017.13	20.4102.022.13	20.4105.022.13
RAL struct.	20.4102.017.16	20.4105.017.16	20.4102.022.16	20.4105.022.16
RAL matt	20.4102.017.18	20.4105.017.18	20.4102.022.18	20.4105.022.18
ARMOR RAL	20.4102.017.19	20.4105.017.19	20.4102.022.19	20.4105.022.19

KAZIWALL SIDE 2 Pieces



| Prefabricated System
| Sales unit: 1 piece

Note: Intermediate profiles in L=900mm
to secure each glass panel separately

Length/Glass thickness	2500 mm / 16.76 mm / 17.52 mm	5000 mm / 16.76 mm / 17.52 mm	2500 mm /21.52 mm	5000 mm/21.52 mm
Colour	Art. no.	Art. no.	Art. no.	Art. no.
mill finish	20.4602.017.10	20.4605.017.10	20.4602.022.10	20.4605.022.10
natural anodized	20.4602.017.11	20.4605.017.11	20.4602.022.11	20.4605.022.11
RAL shiny	20.4602.017.13	20.4605.017.13	20.4602.022.13	20.4605.022.13
RAL struct.	20.4602.017.16	20.4605.017.16	20.4602.022.16	20.4605.022.16
RAL matt	20.4602.017.18	20.4605.017.18	20.4602.022.18	20.4605.022.18
ARMOR RAL	20.4602.017.19	20.4605.017.19	20.4602.022.19	20.4605.022.19



Fixation anchor Fischer FH II 10/10 S AISI 316

- | For outside use
- | Sales unit: 50 pieces

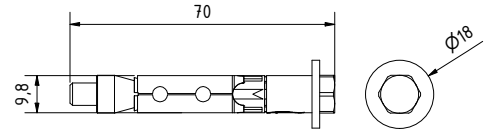

Art. no.

91.3521.010.30

Fixation anchor Fischer SXRL 10x60 FUS steel zinc plated

- | For inside use
- | Sales unit: 50 pieces

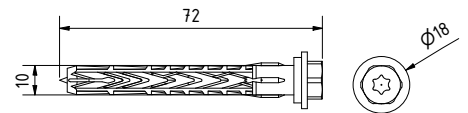

Art. no.

91.3581.060.81

DUOPOWER 8 mm x 65 mm

- | For wall mount of side wall profile
- | Suitable screws: Countersunk screw 5 mm x 70 mm, A2
- | Sales unit: 50 pieces



Duopower

Art. no.

Duopower 8 x 65 S A2

91.3560.865.20

Tape 69



| Particularly suitable for applications where a transparent, flexible bond is required.
 | For inside use
 | Length: 12 m, Thickness: 3 mm
 | Sales unit: 1 piece



Model 7025		
Width	Glass thickness	Art. no.
5 mm	8 - 8.76 mm	90.7025.008.03
7 mm	10 - 10.76 mm	90.7025.010.03
9 mm	12 - 12.76 mm	90.7025.012.03
13 mm	16.76 - 17.52 mm	90.7025.016.03
17 mm	20.76 - 21.52 mm	90.7025.020.03

Tape 69 mounting tool



| Sales unit: 1 piece

Model 0100	
For glass thicknesses	Art. no.
8/8.76 and 10/10.76 mm	90.0100.170.08
12/12.76 and 16.76/17.52 mm	90.0100.170.12
16.76/17.52 and 20.76/21.52 mm	90.0100.170.16

KAZIWALL | TOP

KAZIWALL Tool



| Sales unit: 1 piece

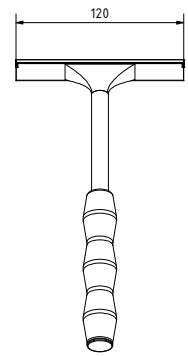

Art. no.

90.0100.190.00

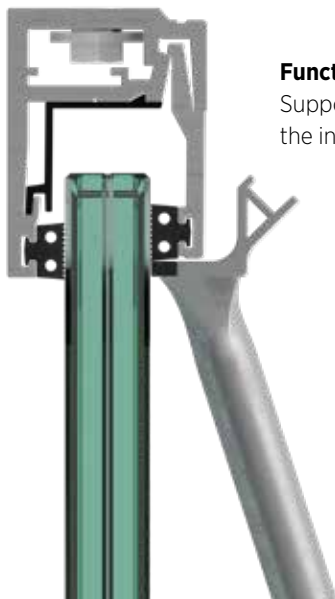

Function 1:
Support tool to hammer-in
the intermediate profile

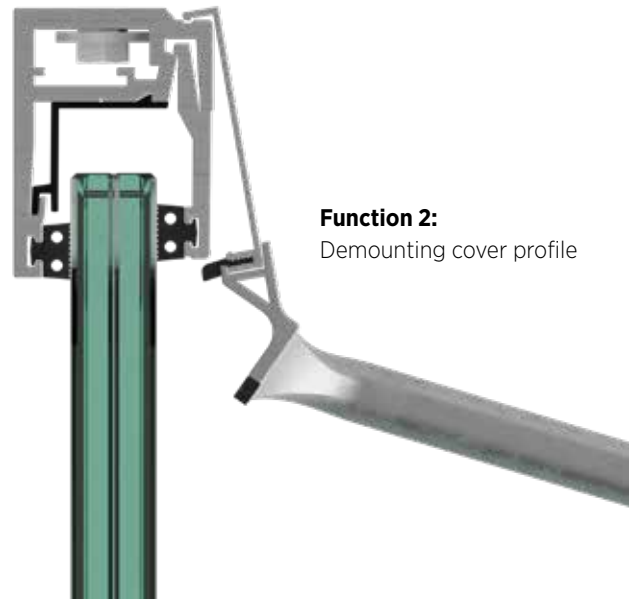

Function 2:
Demounting cover profile

Usage data as per load capacity

Indoor (inside wall)

	Line load	Glass thickness	Height (max)
Private	0.5 kN/m	16.76 mm / 17.52 mm	3000 mm
Public	1.0 kN/m	21.52 mm	3000 mm

Outdoor (as part of exterior wall)

	Line load	Glass thickness	Height (max)	qp(z) max.
Private/Public	1.0 kN/m	21.52mm	2600 mm	1.41 kN/m ²
Private/Public	1.0 kN/m	21.52 mm	3000 mm	0.93 kN/m ²

*All glass calculations are done for laminated toughened glass (ESG)





ONLEVEL

ONLEVEL Ltd. | Units 6 & 7, Alexandria Court | Alexandria Drive
Ashton Commerce Park | Ashton-under-Lyne | Lancashire OL7 0QN | United Kingdom
T +44 0161 804 9500 | F +44 0161 804 9505 | info@onlevel-uk.com | www.onlevel.com